

# ATOMSTACK P9 Series Laser Engraver User Manual

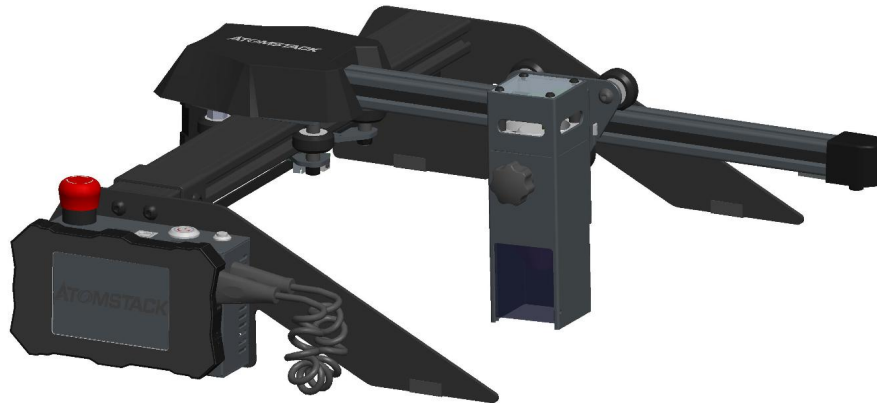

Note: The picture is for reference only, the actual product shall prevail

2010112070 Version: A

*Bitte scannen Sie den QR-Code, um die deutsche Version des Handbuchs zu erhalten.*

*Veuillez scanner le code QR pour obtenir la version française du manuel .*



Laser Engraver

# Part 1:Security Statment Before Installation

**Before using the laser engraving, please read this safety guide carefully, it mentions situations that require special attention and includes warnings of unsafe practices that can cause damage to your property or even endanger your personal safety.**

1. The product belongs to Class 4 laser products, the laser system itself must meet the requirements of IEC 60825-1 latest version, otherwise the product is prohibited to be used.
2. Our laser engraver has a protective case that prevents people from laser radiation when in place.
3. If a protective housing is equipped with an access panel which provides "walk-in" access then:
  - a) means shall be provided so that any person inside the protective housing can prevent activation of a laser hazard that is equivalent to Class 3B or Class 4.
  - b) There is a warning device so as to provide adequate warning of emission of laser radiation equivalent to Class 3R in the wavelength range below 400 nm and above 700 nm, or of laser radiation equivalent to Class 3B or Class 4 to any person who might be within the protective housing.
  - c) Where "walk-in" access during operation is intended or reasonably foreseeable, emission of laser radiation that is equivalent to Class 3B or Class 4 while someone is present inside the protective housing of a Class 1, Class 2, or Class 3R product shall be prevented by engineering means.

Note:Methods to prevent human from radiation when persons are inside the protective housing can include pressure sensitive floor mats, infrared detectors, etc.

4. The laser itself has a protective cover, the protective cover is fastened by screws. When the laser is installed on the laser engraver, the protective cover should be checked to be reliably locked, and can not be removed in the energized state.
5. The housing of the laser engraver have an interlock function. When the housing is opened or removed, the laser can be automatically turned off.
6. The laser engraver have an emergency stop button, which can immediately stop the output of the laser when pressed under unexpected circumstances.
7. The laser engraver have a reset button, which can resume work under the condition of confirming safety after lifting the interlock or emergency stop.
8. Laser engraver use physical keys, dongle, password system and other ways to manage and control, and prevent personnel without safety training from operating such equipment.
9. Set a warning mark on any window or channel that can actively observe or passively receive laser radiation on the laser engraving machine.
10. If the laser burns the skin or eyes, please go to a nearby hospital for examination and treatment immediately.

# Part 2:User Security Statement

Laser light can hurt the human eyes and skin. Do not expose the eye or skin to laser light directly. This Laser product has an optical lens and emits a collimated laser beam. The light emitted by the product, whether it is direct or reflected, is very harmful. Because it can propagate a long distance while maintaining high optical density. When handling the product, you must wear appropriate goggles(OD5+) to protect eyes from laser light including reflected and stray light. The reflected and stray light spilling into an unintended area should be attenuated and/or absorbed.

## **2.1 Laser safety**

We installed a laser shield on the laser, the shield can largely filter out the diffuse reflection of the laser spot. However, when using laser engraving machine, it is recommended that you should wear laser protective glasses. Avoid skin exposure to type 4 laser beams, especially at the closed distance. Teenagers must have parental supervision in the process of using it. Do not touch the laser engraving module when the machine is activated.

## **2.2 Fire safety**

Because cutting burns off the substrate, a high-intensity laser beam generates extremely high temperatures and a lot of heat. Certain materials can catch fire during cutting, creating gases and fumes inside the equipment. A small flame usually appears here when a laser beam hits the material. It will move with the laser and will not stay lit when the laser passes by. Do not leave the machine unattended during the engraving process. After use, be sure to clean up the debris, debris and flammable materials in the laser cutting machine. Always keep an available fire extinguisher nearby to ensure safety. When laser engraving machines are used, smoke, vapour, particles, and potentially highly toxic materials (plastics and other combustible materials) are produced from the material. These fumes or air pollutants can be hazardous to health.

### **2.3 Material safety**

Do not engrave materials with unknown properties. Materials Recommended:Wood, bamboo, leather, plastic, fabric, paper, opaque acrylic, glass. Materials not recommended:Metal, precious stones, transparent materials, reflective materials etc.

### **2.4 Use Safety**

Use the engraver only in horizontal position and ensure that it has been securely fixed to prevent fires caused by accidental shifting or dropping from the workbench during work. It is forbidden to point the laser to people, animals or any combustible object, whether it is in working condition or not.

### **2.5 Power safety**

To prevent accidental disasters such as fire and electric shock, the laser engraver provides a power adapter with a ground wire. When using the laser engraving machine, insert the power plug into a power socket with a ground wire with a ground wire when using the Laser Engraver.

### **2.6 Environment safety**

When installing engraving and cutting equipment, please make sure that the workplace must be cleaned up, and there should be no flammable and explosive materials around the equipment. A metal plate must be placed under the bottom when engraving or cutting.

# Part 3:Disclaimer and warning

This product is not a toy and is not suitable for people under 15. Do not allow children to touch the laser module. Please be careful when operating in scenes with children.

This product is a laser module, visit <http://www.atomstack3d.com/laserengraverdownload> to get the complete "user manual" and the latest instructions and warnings. Shenzhen AtomStack Technologies Co., Ltd. (Atomstack) reserves the right to update this Disclaimer and Safe Operation Guidelines.

Please be sure to read this document carefully before using the product to understand your legal rights, responsibilities and safety instructions; Otherwise, it may bring property loss, safety accident and hidden danger of personal safety. Once you use this product, you shall be deemed to have understood, and accepted all terms and contents of this document. User undertakes to be responsible for his or her actions and all consequences arising therefrom. User agrees to use the Product only for legitimate purposes and agrees to the entire terms and contents of this document and any relevant policies or guidelines that AtomStack may establish.

You understand and agree that Atomstack may not be able to provide you with the cause of the damage or accident and provide you with AtomStack's after-sale service unless you provide the original engraving or cutting files, engraving software configuration parameters used, operating system information, video of the engraving or cutting process, and operational steps prior to the occurrence of a problem or failure.

Atomstack is not liable for any and all losses arising from the user's failure to use the product in accordance with this manual, Without the guidance of the company's technical personnel, users are prohibited from disassembling the machine by themselves. If this behavior occurs, the loss caused by the user shall be borne by the user.

Atomstack has the ultimate right to interpret the document, subject to legal compliance. Atomstack reserves the right to update, modify, or terminate the Terms without prior notice.

# Part 4: Engraving machine introduction

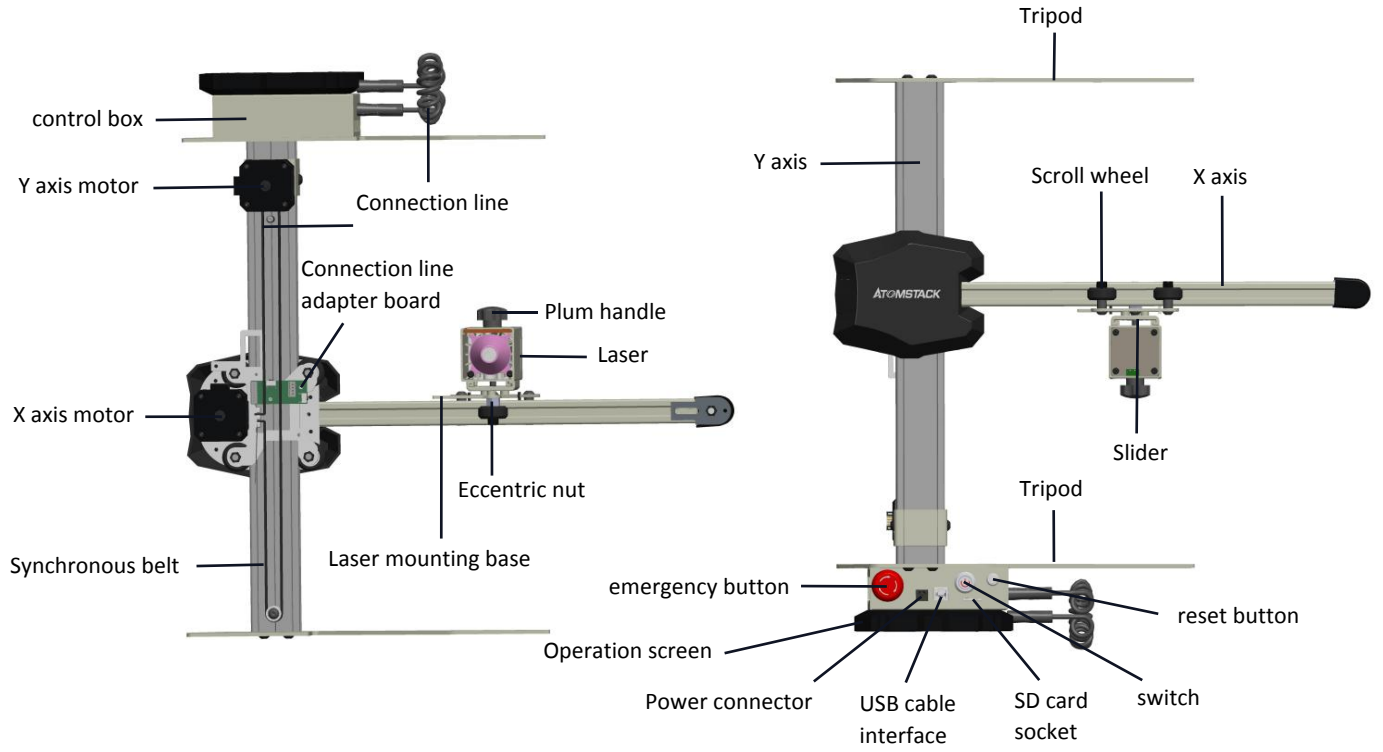

# Part 5: Assembling instruction

## Step 1: Assembling instruction of X-Axis and Y-Axis

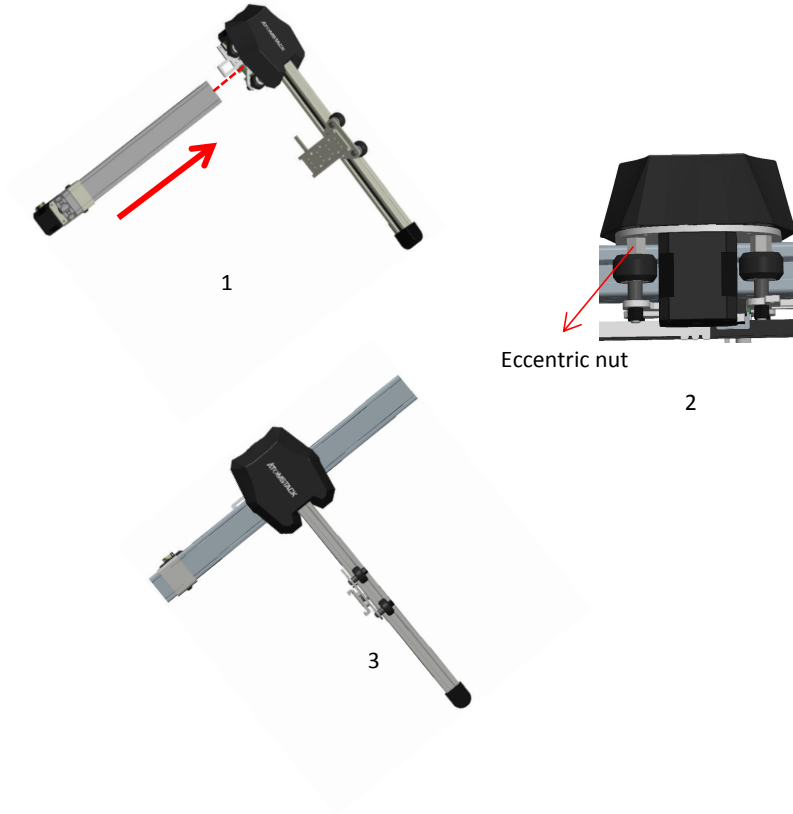

## Components required



Y-axis component

X-axis component

1. Push the X-axis component along the dotted line into the guide rail frame of the Y-axis component according to the direction shown in the figure. Before pushing the X-axis component into the Y-axis frame, properly loosen the eccentric nut to avoid the roller on the X-axis component is too tight when pushing X-axis component into the Y-axis frame.
2. After pushing the X-axis component into the Y-axis guide rail, properly tighten the eccentric nut on the X-axis component to prevent the roller on the X-axis component from loosening.
3. The figure completely displays the X/Y axis component after assembling.



## Step 2: Assembling instruction of Y-Axis Bracket

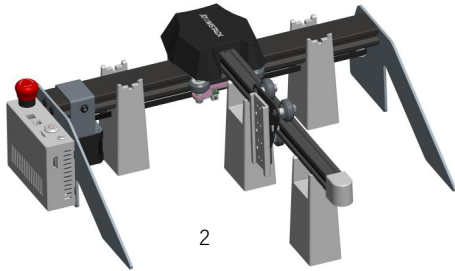
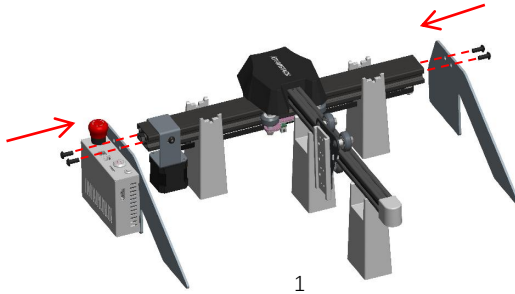

### Components required



Lower support  
foot component



Upper support  
foot and control  
box component



Y-axis bracket screws  
on both sides M5\*14



Assembly pad

1. As shown in Figure 1, two assembly blocks are used to install the Y-axis and one assembly block is used to install the X-axis. They are respectively clamped in different grooves, and then the upper support foot and the lower support foot assembly are assembled, and the support foot components and M5\*14 screws are assembled to the screw holes of the Y axis along the dotted lines on both sides, and tighten the screws with a No. 4 Allen screwdriver

2. Figure 2 shows the complete assembly after the Y-axis upper support foot and lower support foot assembly and M5\*14 screws are tightened.

### Step 3: Assembling instruction of Synchronous belt

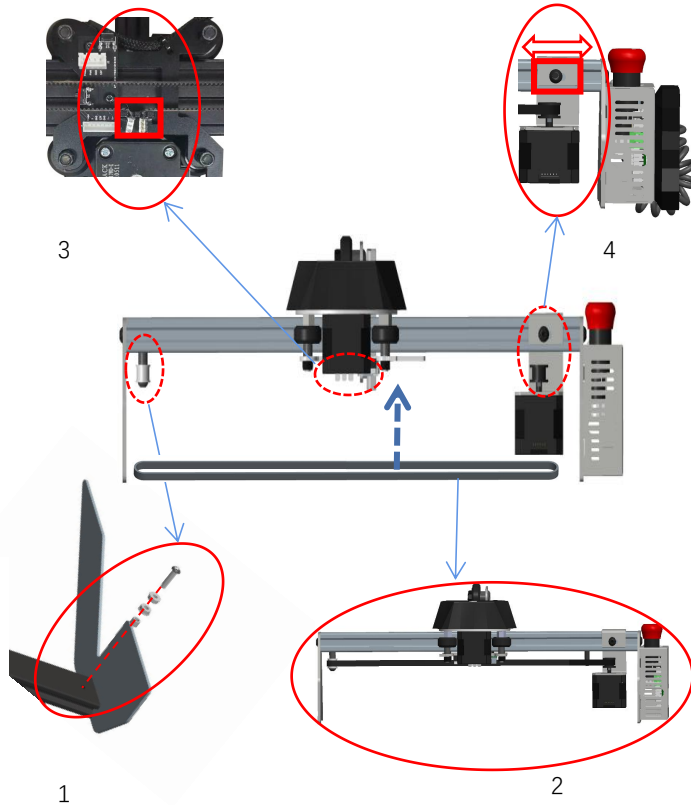

### Components required

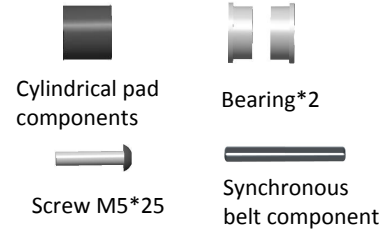

1. As shown in Figure 1, install the cylindrical pad, two bearings (note the direction), and M5\*25 screws along the dotted line to the Y-axis frame screw holes at the same time, and tighten the screws with a No. 4 hexagon socket screwdriver.
2. As shown in Figure 2, install the timing belt into the two timing wheels in the direction of the arrow.
3. As shown in Figure 3, after the timing belt is installed on the timing wheel, the two copper heads need to be buckled into the X-axis frame buckle.
4. As shown in Figure 4. To prevent the timing belt from being too loose, please loosen the M5\*14 screws on both sides of the Y-axis motor fixing frame, and move the fixing frame to the right to tension the timing belt.

#### Step4. Assembling instruction of Laser Module

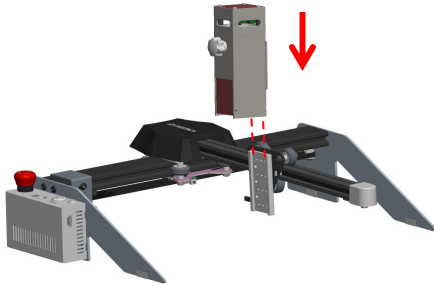

1

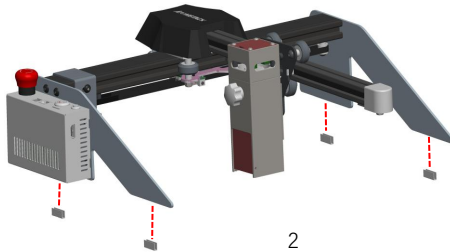

2

#### Components required



laser module



Foot pad foam  
components

1. According to the figure, insert the laser module into the X-axis slide rail block vertically along the dotted line, and then tighten the torx handle. The torx handle can be adjusted to move the laser module up and down. The limit position for the laser module to move up is where the bottom of the laser is level with the bottom of the slider. The maximum downward movement distance for the laser module is 72mm.
2. According to the figure, paste the foam along the dotted line to the stand of the engraver.

### Step5. Assembling instruction of connectivity cable

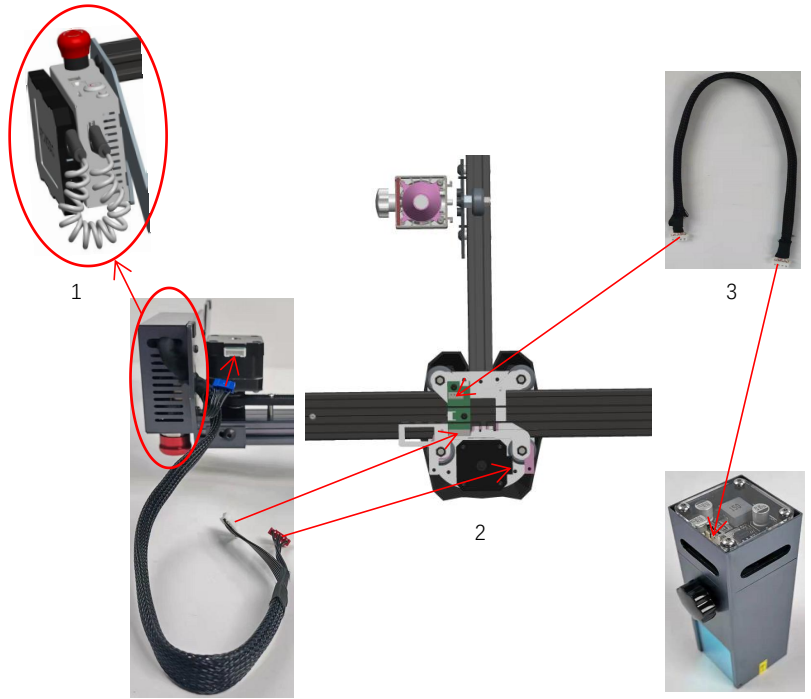

1

3

2

Control box connection line

Laser

1. As shown in Figure 1, insert the two ends of the data transmission line into the control box and the control operation panel ports respectively.
2. As shown in Figure 2, according to the direction of the arrow, insert the two 6PIN terminals on the control box connection line into the XH6 socket sockets on the X-axis and Y-axis motors respectively, and then insert the control box connection line 7PIN terminal into the adapter board XH7 socket socket.
3. As shown in Figure 3, in the direction of the arrow, insert the 4PIN terminals at both ends of the laser cable into the XH4 sub-port of the laser and the XH4 sub-port on the adapter board.

## Part 6:Control box description



1. Emergency stop switch: In case of emergencies, the machine will immediately stop working when you press it. When you need to unlock it, turn the button clockwise to restart the engraver.
2. Power socket: DC 12V power supply.
3. USB interface: control the engraver on the computer with connecting to the computer through a USB cable.
4. Power switch: control the power on and off.
5. TF card slot: here to insert the TF card.
6. Reset switch: When an emergency occurs or the machine is stuck, press the reset button to restart the engraver.

## Part 7: Instructions for use of the display

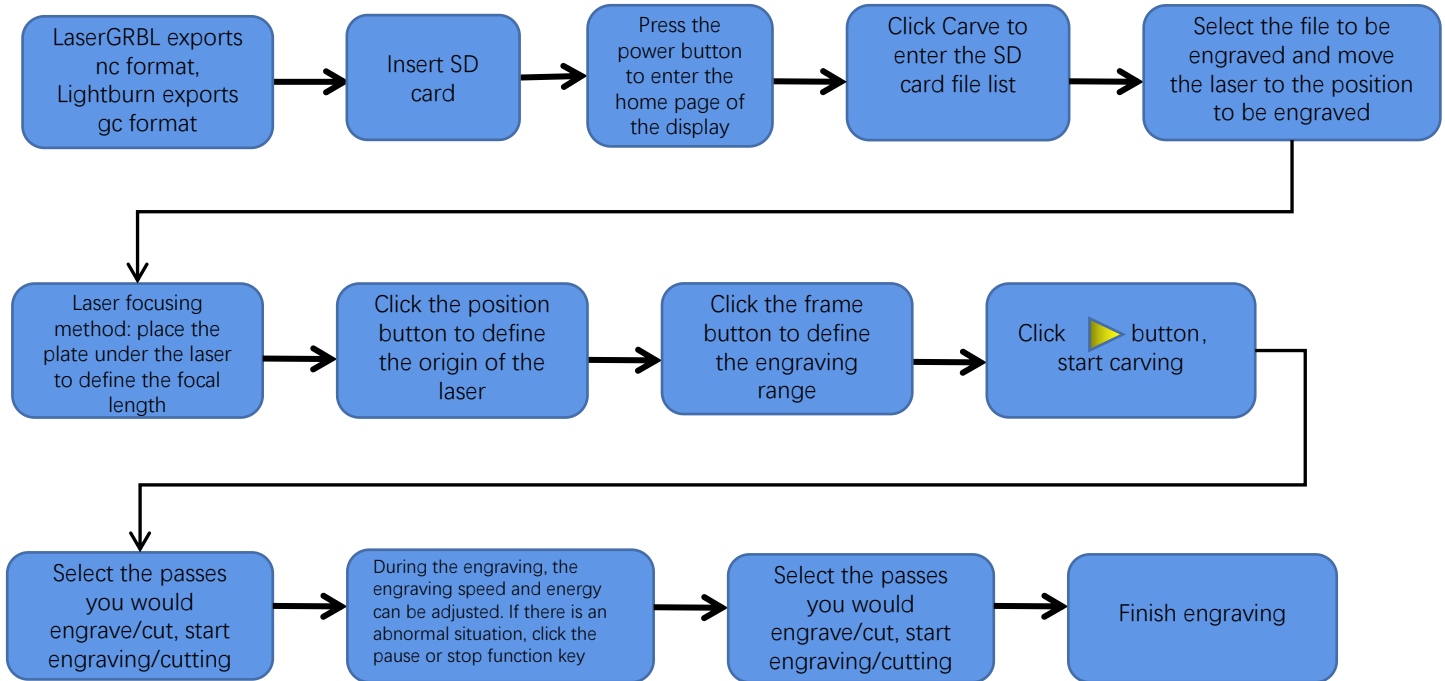

# Instructions for exporting nc and gc format files

## 1. LaserGRBL software

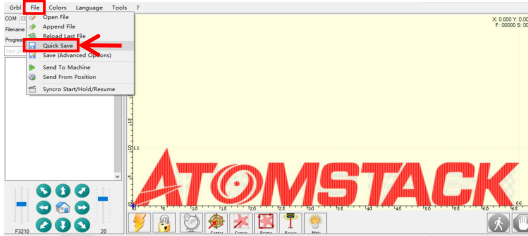

1.Import the picture to be engraved or cutted into laserGRBL, after setting the engraving speed and energy parameters etc., click File, and select Quick Save

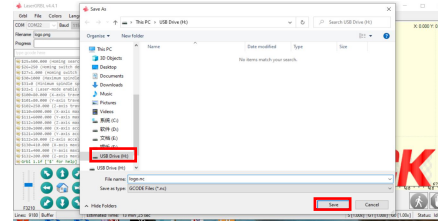

2.Select sd chuck as the save path, click Save to generate nc file.

## 2.Lightburn software

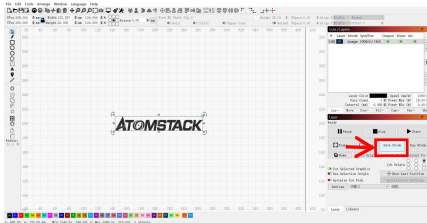

1.Import the picture to be engraved or cutted into lightburn, after setting the engraving speed and energy parameters etc., click Save Gcode.

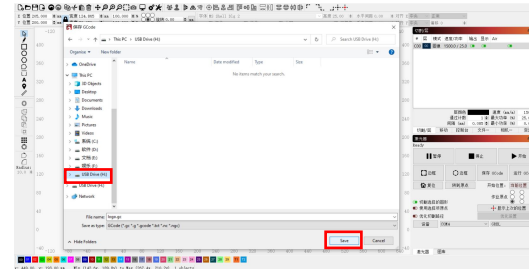

2.Select TF chuck as the save path, click Save to generate gc file.

# Introduction to the contents of the home page, file list, and engraving preparation page of the display



1、 Before using the engraving machine, please insert the SD card into the control box card slot along the dotted line. If the SD card is not inserted, the engraving machine cannot be operated after entering the operation display. When inserting the card, pay attention to the front and back of the SD card. Insert the card into the card slot on the reverse side (see the picture for correct insertion)

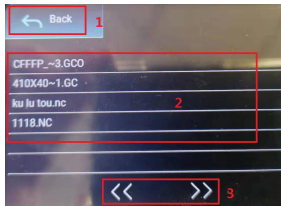

**3、 This is the engraving file list interface, which can perform file name selection, page up and down, and return to the startup interface.**

1. Click the back button to return to the boot interface.
2. Select the corresponding file name to enter the engraving preparation interface.
3. Click the left and right page buttons to turn the file name up and down.



**2、 This is the boot interface, which has two major functions.**

1. Click the Carve button to enter the engraving file list interface.
2. Click the Setting button to enter the setting interface.



**4、 This is the engraving preparation interface, which can perform engraving start, X/Y axis movement, center point, contour scanning, and positioning operations.**

1. Click the back button to return to the engraving file list interface and the startup interface
2. Engraved file name
3. Click the up, down, left and right arrow function buttons to move the Y axis and X axis, click the arrow middle button to return to the zero position of the X/Y axis, "0.1, 1, 10" are the X/Y axis travel distance values, select different values The travel distance of X/Y axis is also different. The maximum engraving range is "X: 250, Y: 220". The coordinates will change with the movement of X/Y axis.
4. After clicking the engraving start button, the engraving times can be set. The engraving machine executes the engraving action
5. Click the center point button to set the position of the laser center point
6. Click the contour scan button, the laser can automatically walk the engraving file size range (Note: when the engraving file nc or .gc file is larger than 1M, the laser will automatically walk for a long time, and it will take about 2-10 minutes).
7. After clicking the positioning button, click the confirm button to locate the starting point of the laser



# Setting of engraving/cutting passes, introduction of page key functions in engraving

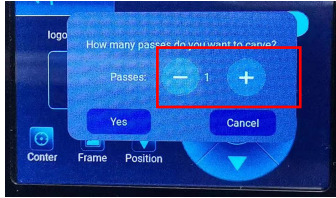

## 1. This is the setting interface of engraving times

Click "+/-" to set the number of times of engraving. After setting, click the confirm button to enter the engraving interface.

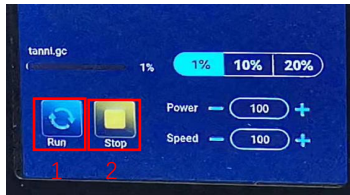

## 3. This is the pause engraving interface.

1. After clicking Pause, the laser will stop the engraving action and the machine will stop running. Click the resume engraving button to continue the engraving just now.

2. Click the stop button to end laser engraving and printing.

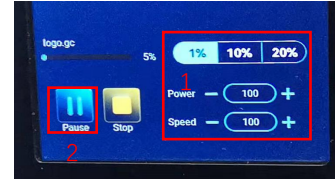

2. This is the interface during engraving. This interface can be paused, stopped, and the power and speed can be adjusted. (Note: There is no return button in this interface. You can only stop working and return to the engraving preparation interface. After the engraving is completed, it will return to the engraving preparation interface. The head will move to the starting position of the last engraving to facilitate repeated engraving of the unified file.

1. Click the "+/-" button to adjust the power and speed, "1%, 10%, 20%" is the percentage value of the power and speed adjustment, select a different percentage value, and click the "+/-" button value Also different.

2. Click the pause button to pause the laser engraving operation.

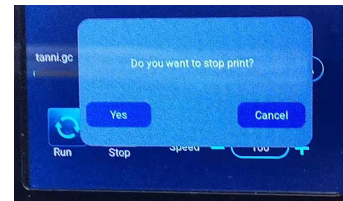

## 4. This is the interface that pops up when you click to stop engraving.

After clicking the stop button, a confirmation window will pop up, click confirm to stop engraving and printing, and the interface will return to the boot interface

## Setting of engraving/cutting passes, introduction of page key functions in engraving

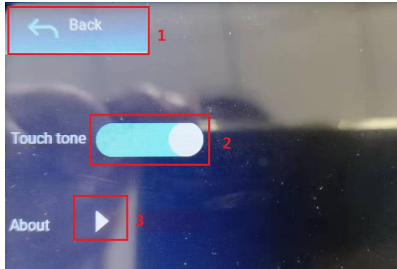

### 9、 This is the setting interface.

- 1.Click the back button to return to the boot interface
- 2.Click the key tone switch button to turn on/off the key tone.
- 3.Local information

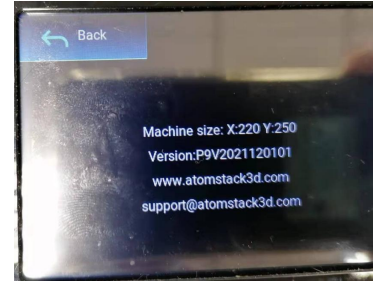

### 10、 This is about the interface of this machine.

This interface displays the size of the device engraving, firmware version, company website, and customer email address.

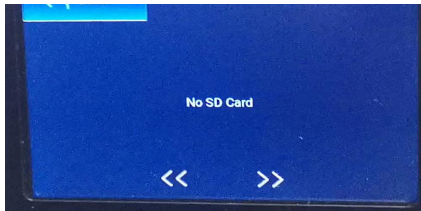

### 11.This is the interface without SD card inserted,

## Part 8: Software installation and use

1. Downloading LaserGRBL software
2. Installing LaserGRBL
3. Adding custom buttons
4. Connect laser engraving machine
5. Setting Engraving Parameters
6. Laser focus adjustment
7. Positioning
8. Start, Termination carving or cutting
9. LightBurn Installation Tutorial

## 1. Downloading LaserGRBL software

LaserGRBL is one of the most popular DIY laser engraving software in the world, LaserGRBL download website:  
<http://lasergrbl.com/download/>

## 2. Installing LaserGRBL

Double-click the software installation package to start the software installation, and keep clicking Next until the installation is complete.(Picture1)

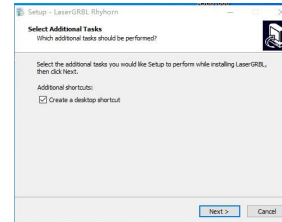

Picture1: LaserGRBL software installation

## 3. Adding custom buttons:

1.The software supports users to add custom buttons, you can add custom buttons in the software according to your usage. We recommend the official Custom Buttons from LaserGRBL. Custom button download address:  
<http://lasergrbl.com/usage/custom-buttons/>. The downloaded custom button is displayed as shown in the figure. (Picture2)



Picture 2:custom button package

2.Next, we will load the custom buttons into the LaserGRBL software. In the LaserGRBL software, right-click on the blank space next to the bottom button (as shown in Picture 3) -> Import custom button, then select the custom button zip file downloaded ATOMSTACK to import, keep pressing Yes (Y) until no window pops up. (Picture 4、 Picture 5)



Picture 3: adding custom button

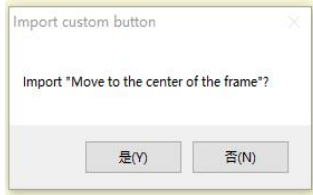

Picture 4: custom button loading

The installed software is shown as the following figure.

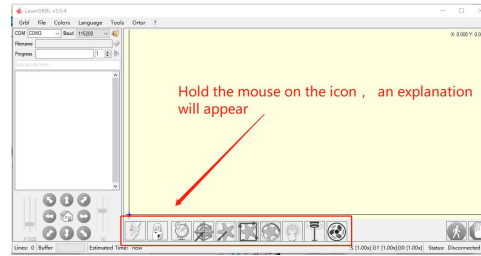

Picture 5: Software button

#### 4. Connect laser engraving machine

- A. Connect the engraver to a computer with LaserGRBL software installed.
- B. Plug in the power supply of the engraving machine.
- C. Open the LaserGRBL software
- D. Select the correct port number and baud rate in the software - 115200, (in general, COM ports do not need to be selected manually, but if you have more than one serial device connected to the computer, it needs to do so, you can find the port of the laser engraver in the device manager of the Windows system, Or you can simply try the port numbers displayed one by one).

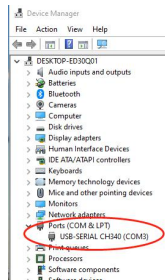

Check the port number

E.First, install CH340 Driver. In the LaserGRBL software, click "Tools">"install CH340 Driver" to install the driver, and restart the computer after installation to connect.

F.Click on the lightning connection logo in the software. When the lightning logo changes to a red X, the connection is success.

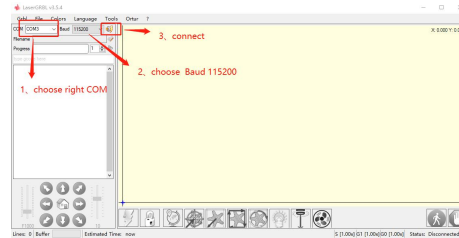
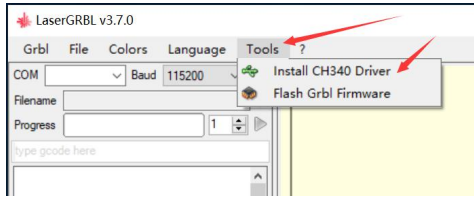

Connect the engraving machine

G. The computer and engraving machine chain machine failure, need to update the drive, the method is as follows

In LaserGRBL, click "Tools" > in turn.Linstall CH340 Driver "Update and install the Driver", restart the computer after the update, and then connect, as shown in the picture below.

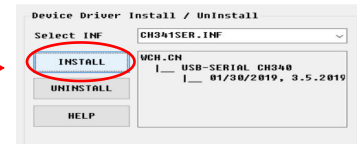
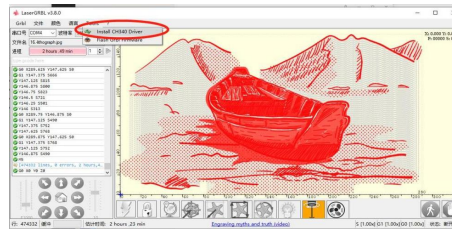
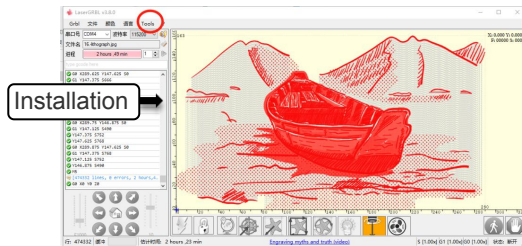

## 5. Setting engraving parameters

1. Select the engraving file.

Open LaserGRBL software, click "File"> "Open File", then select the graphics you want to engrave, LaserGRBL supports NC, BMP, JPG, PNG, DXF and other formats.

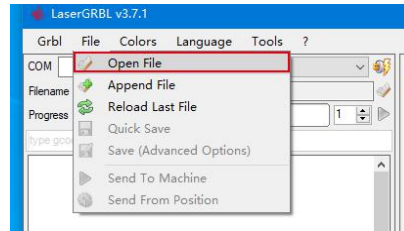

### Open file

2. Picture parameters, engraving mode, engraving quality settings

a. LaserGRBL can adjust the sharpness, brightness, contrast, highlight and other attributes of the target picture, when adjusting the parameters of the picture, the factual effect will be shown in the right preview window, there is no standard here, just adjust the effect you want.

b. Engraving mode usually choose "line to line tracking" and "1bit dithering", 1bit dithering is more suitable for engraving grayscale graphics. If you are going to cut, select the vector graphics or centerline engraving mode.

c. Engraving quality essentially refers to the line width of the laser scan, this parameter mainly depends on the size of the laser spot of the engraving machine, it is recommended to use an engraving quality of 8, The response to laser illumination varies from different materials, so the exact value depends on the specific engraving material.

d. at the bottom of the preview window, the image can also be rotated, mirror, cut, etc. operations.

e. After completing the above settings, click next to the the settings of carving speed, carving energy and carving size.

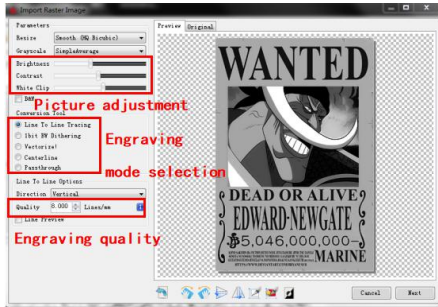

Introduction of Setup Interface

**Speed recommendation 3000**

**Input appropriate energy according to your material**

**Enter the appropriate size according to the contour of the object to be carved**

3. Engraving speed, engraving energy and engraving size Setting  
a. recommending the engraving speed for 3000, this is the best value for the engraving effect after repeated experiments, of course you can increase or decrease the speed according to your preference, faster speed will save the engraving time, but it may reduce the engraving effect, slower speed is the opposite.

b. In the selection of the laser mode, there are two commands for laser, M3 and M4, it is recommended to use the M4 command for 1bit litter engraving, and M3 command for other cases. If your laser only has M3 instruction, please check whether the laser mode is enabled in the GRBL configuration, please refer to the official instructions of LaserGRBL for GRBL configuration.

c. Choose the engraving energy according to different materials, we have attached the engraving and cutting parameters of common materials at the end of the manual for your reference.

d. Finally, set the size you want to engrave, click on the "Create" button, all the engraving parameters has been set.

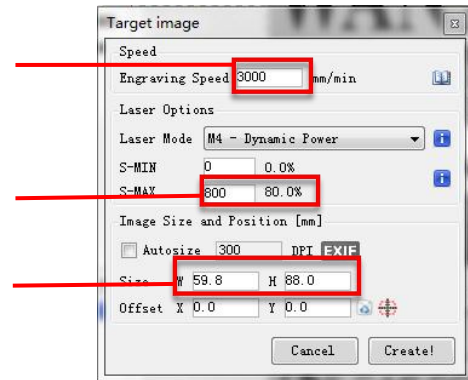

Picture 3.10 Setting of engraving speed and laser power



## 6. Laser focus adjustment

The effect of engraving or cutting depends largely on whether the laser is focused, most of the existing laser engraving machines on the market use a zoom laser, need to rotate the focus nut while staring at the laser dot with your eyes to observe whether the laser is focused. Staring at the laser dot for long periods of time can damage your eyes (even with goggles), What's more, it's difficult to distinguish small changes in focus, so it's hard to find the best laser focus point.

To solve this problem, we have abandoned the traditional zoom laser and installed a fixed-focus laser on the Atomstack engraver, with the specific focus point located 2mm from the bottom of the acrylic cover, and a fixed-focus piece is included in the package. To use the laser, simply adjust the height of the laser (one fixed focus piece away from the top surface of the object being engraved or cut) .

The following is the specific operations:

- A. Moving the laser head over the object to be engraved or cut.
- B. Placing a fixed-focus piece on the object to be engraved or cut.

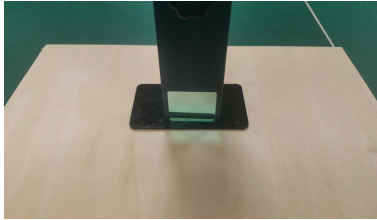

Placing fixed-focus piece

Acrylic bottom to  
Engraved surface 2mm

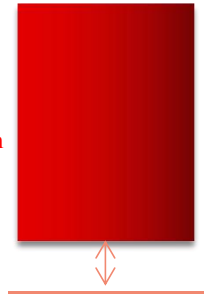

**Laser focus**

C. Loosen the Torx handle screw in the middle of the laser, and let the laser slide freely until it touches the fixed focus plate (after contact, you can gently lift the laser and take out the fixed focus plate).



Adjusting the laser distance

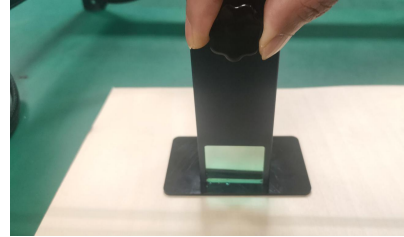

fixing screws

D. Tighten the Torx handle screw in the center of the laser.

E. Take out the fixed focus piece and finish focusing.

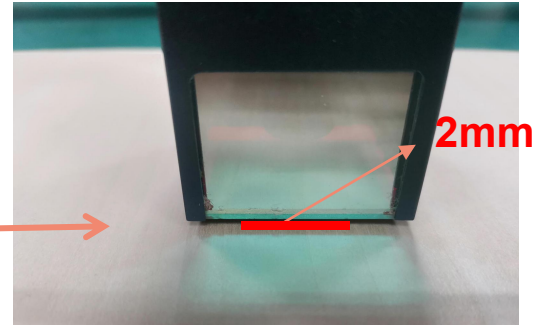
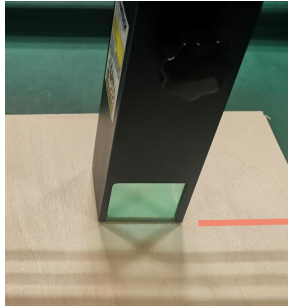

Take out the fixed focus piece

## 7. Positioning

A. The engraver does not know what position to carve, so there is one important task ATOMSTACK you start carving, that is positioning. We will complete the positioning operation in three steps.

B. Select the "Move to Center" button, the laser will move to the center of the pattern, placed the engraving below the laser at that time.

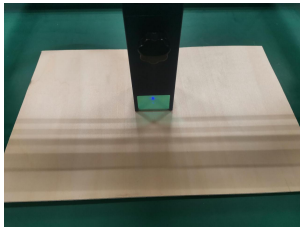
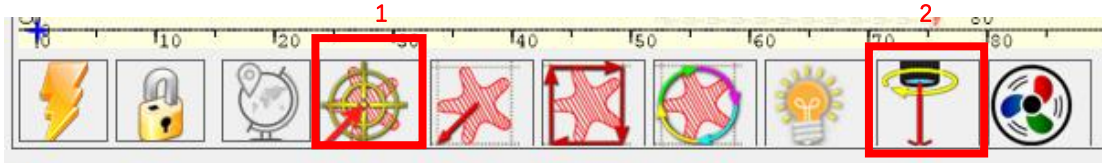

Step1: Move to Center



Step2: light laser

C. Click "light laser" button, the laser will emit a weak light, the laser emits irradiation point is the center of the engraving pattern, based on this, adjust the position of the engraved object!

D. Click "Profile Scan" button, the laser will start to scan the outer contour of the pattern on the computer, you can change the position of the engraved object again according to the scanned outer contour position. Besides, You can click on the "wrap-around" button for several times until the outer contour is at the position you want to engrave.

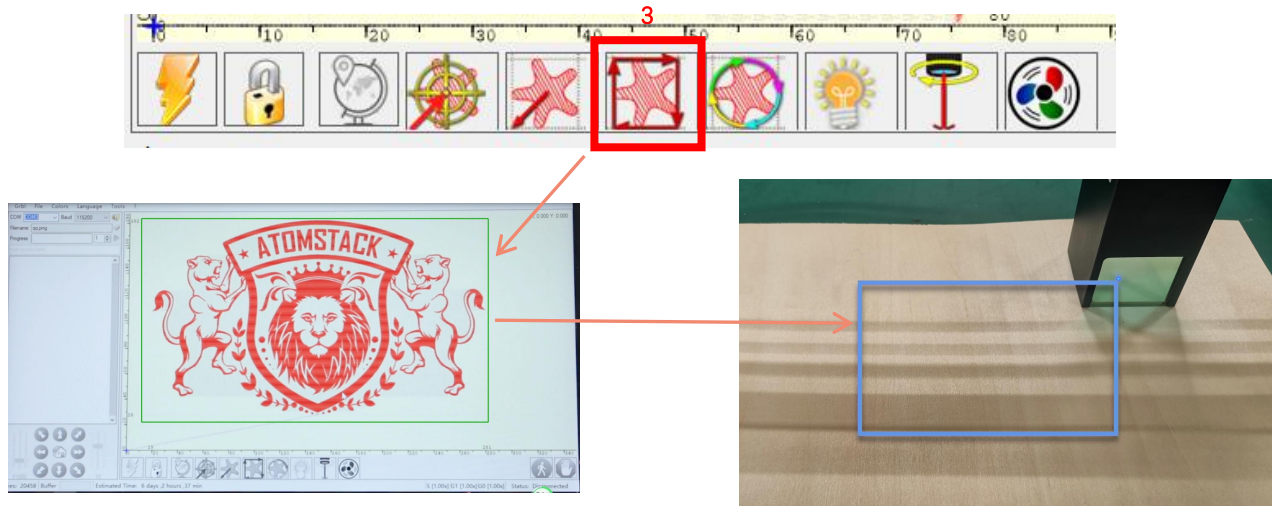

Step3: Profile Scan

## 8. Start, Termination carving or cutting

### 1. Start:

After finishing all the above operations, click the green button as shown in the figure to start engraving. There is a number that can be edited next to the start button. It is the number of times of engraving or cutting, LaserGRBL allows multiple consecutive engraving or cutting of uniform shapes, this function is especially useful for cutting.

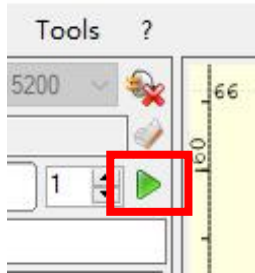

Picture 1 Start

### 2. Termination

If you want to terminate the job midway, you can click the terminate button as shown in the picture to terminate the engraving or cutting.

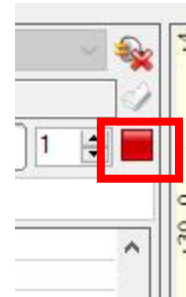

Picture 2 Stop

## 9. LightBurn Installation Tutorial

We can download the installation package from the LightBurn website:

<https://lightburnsoftware.com/>

Double-click on the installation package to install and click "Next" in the pop-up window.

(Note: LightBurn is a paid software, for better experience we recommend you to buy the original one, here we will demonstrate the installation of the trial version)



Picture3:  
LightBurn  
Software package

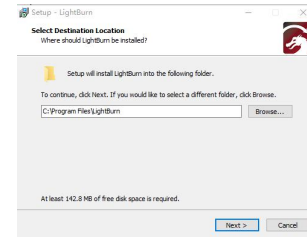

Picture 4:  
Select the  
installation path

Click Start Your Free Trial (Picture 5)



Picture 5: Choose  
a free trial

Click Find My Laser (Picture 6)

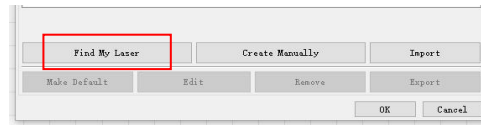

Picture 6: Click "Find my laser"

Click Find My Laser (Picture 7)

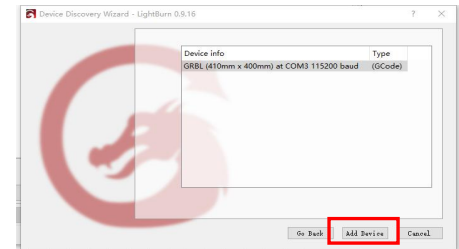

Picture 7: Click **GRBL**  
(410\*400mm), Click add Device

To set the origin, we usually set the origin in the front left.

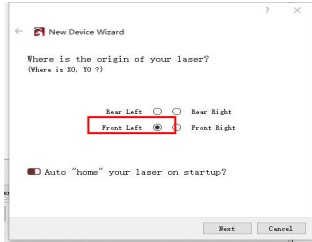

Picture 8: set the origin in the Front left.

If the computer fails to connect to the machine, we can select the port of the laser engraver like the following picture.

### Method 1:

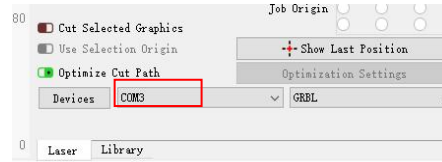

Method 2: update drive, log on website <http://atomstack3d.com/a5> click lightburn drive download, as shown below.

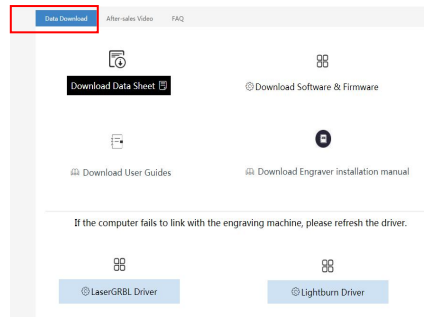

## Part 9: Techniques for using machines

1. The closer the laser is to the table, the less stable the structure will be, try to elevate the laser as far away from the table as possible.
2. Precise positioning of the pattern and the engraved object.
  - a. Move the laser to the lower left of the frame.
  - b. Using a ruler and pencil to draw a center point on the engraved object (Picture 1).
  - c. The shield must be parallel to the edge of the engraved object (Picture 2).



Picture 1 draw a center point on the engraved object

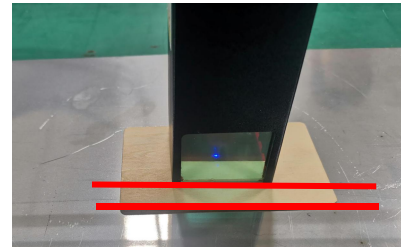

Picture 2 The shield is parallel to the edge of the engraved object

- d. Click on the following two buttons in sequence to move the laser so that the laser point moves to the center of the engraving. Once the positioning is complete, you can start engraving.

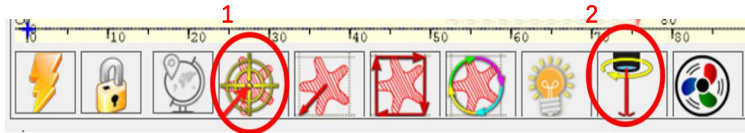

Picture 3 center point positioning



## Part 10: Maintenance instructions and warning

This product uses a highly integrated design and requires no maintenance. However, if the laser system installed with this product needs to be repaired or adjusted, please:

1. Unplug the power connector on the laser, so that the laser is in a state of power failure;
2. If you need laser assistance for adjustment, please:
  1. All present personnel wear protective glasses, OD5+ protective glass is needed ;
  2. Make sure there are no flammable or explosive materials around;
  3. The position and direction of the laser are fixed to ensure that the laser will not accidentally move and shine on people, animals, flammable, explosive and other dangerous and valuable objects during debugging.
  4. Don't look at lasers
  5. Do not shine the laser on the mirror object, lest the laser reflection cause accidental injury.

### 3.Laser module cleaning

After a period of utilization for the laser module, there will be some remains stay at the protective cover, heat sink, and the laser head. The remains need to be cleaned in time so that not affect the use of the laser module.

The windshield and protective cover must be removed before cleaning.

1.Please clean the protective cover and heat sink with the alcohol and non-woven fabric shown as chart 1.

2. Please clean the laser head with the alcohol and non-woven fabric shown as chart 2.

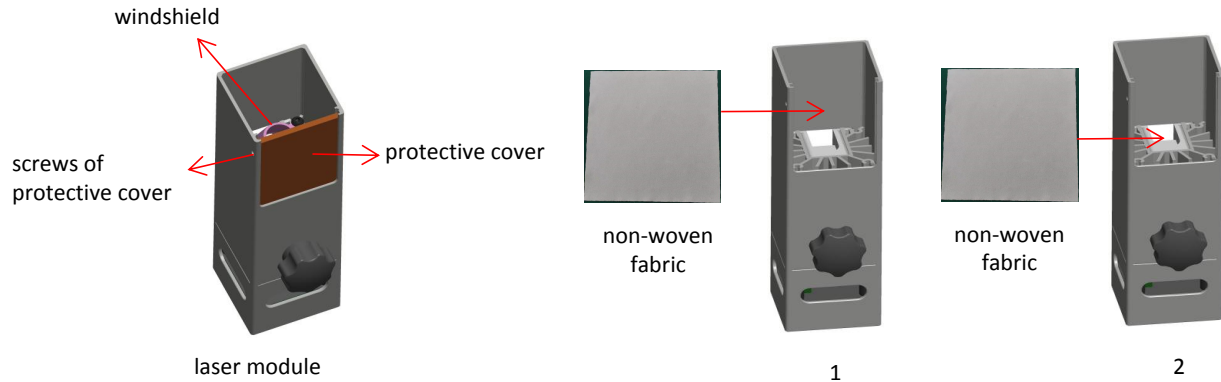

## Part 11: Precautions for common problems

1. Please select the correct COM port for connecting the software and equipment, and the baud rate should be selected: 115200, to ensure that the connection between the computer port and the USB cable is not loose. If you need laser assistance for tuning, please:
2. Before engraving, please confirm whether each mechanism is loose (synchronous belt, eccentric column of roller, and laser head are loose or shaken)
3. Correctly adjust the focus and confirm that the distance from the end of the laser protective cover to the engraving is 2mm.
4. LaserGRBL/LightBurn software can refer to the parameter table in the corresponding manual for engraving and cutting of different materials. The engraving of mirror metal requires manual surface blackening treatment.



## Customer Service:

Ø For detailed warranty policy, please visit our official website at: [www.atomstack.net](http://www.atomstack.net)

Ø For Laser Engraver technical support and service, please email: [support@atomstack.net](mailto:support@atomstack.net)

**Manufacturer:** Shenzhen AtomStack Technologies Co., Ltd.  
Address: 202, Building 1, Mingliang Technology Park, No. 88 Zhuguang North Road, Taoyuan Street, Nanshan District, Shenzhen, Guangdong, China

Scan the code to enter the engraving machine discussion group



Scanner APPLICATION:  
QR code reader  
/ Barcode scanner  
or any APP with scanner